



**DEVELOPERS LIVE**

# **Content Delivery with AEMaaCS**

Tips to setup your project to deliver fast experiences

**Mike Tilburg | Manager, Software Development**

**Ian Boston | Principal Scientist**



# Agenda

**Introduction to Content Delivery in AEMaaCS**

**Demo**

**Tips for Success**

**Questions**

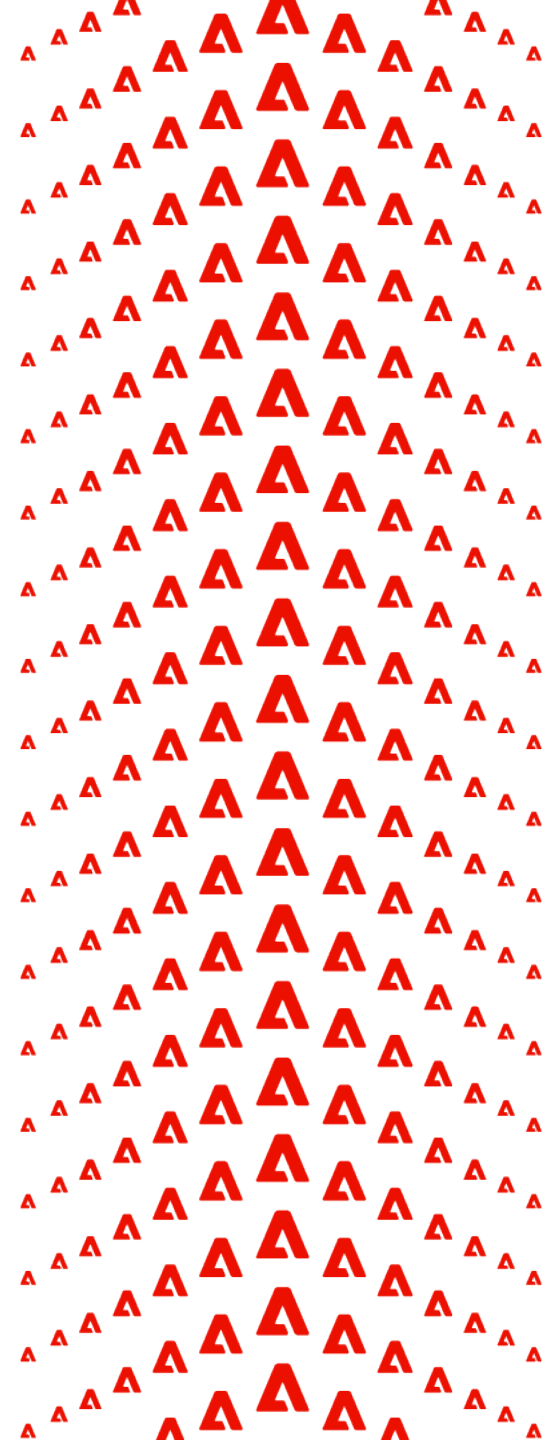

# Delivering a Fast Experience

**AEM as a Cloud Service enables you to deliver a new, fresh experience globally**

**Difference of 250 Milliseconds can give a competitive advantage**

**Difference of 400 Milliseconds is unconsciously influencing the user**



# AEM as a Cloud Service

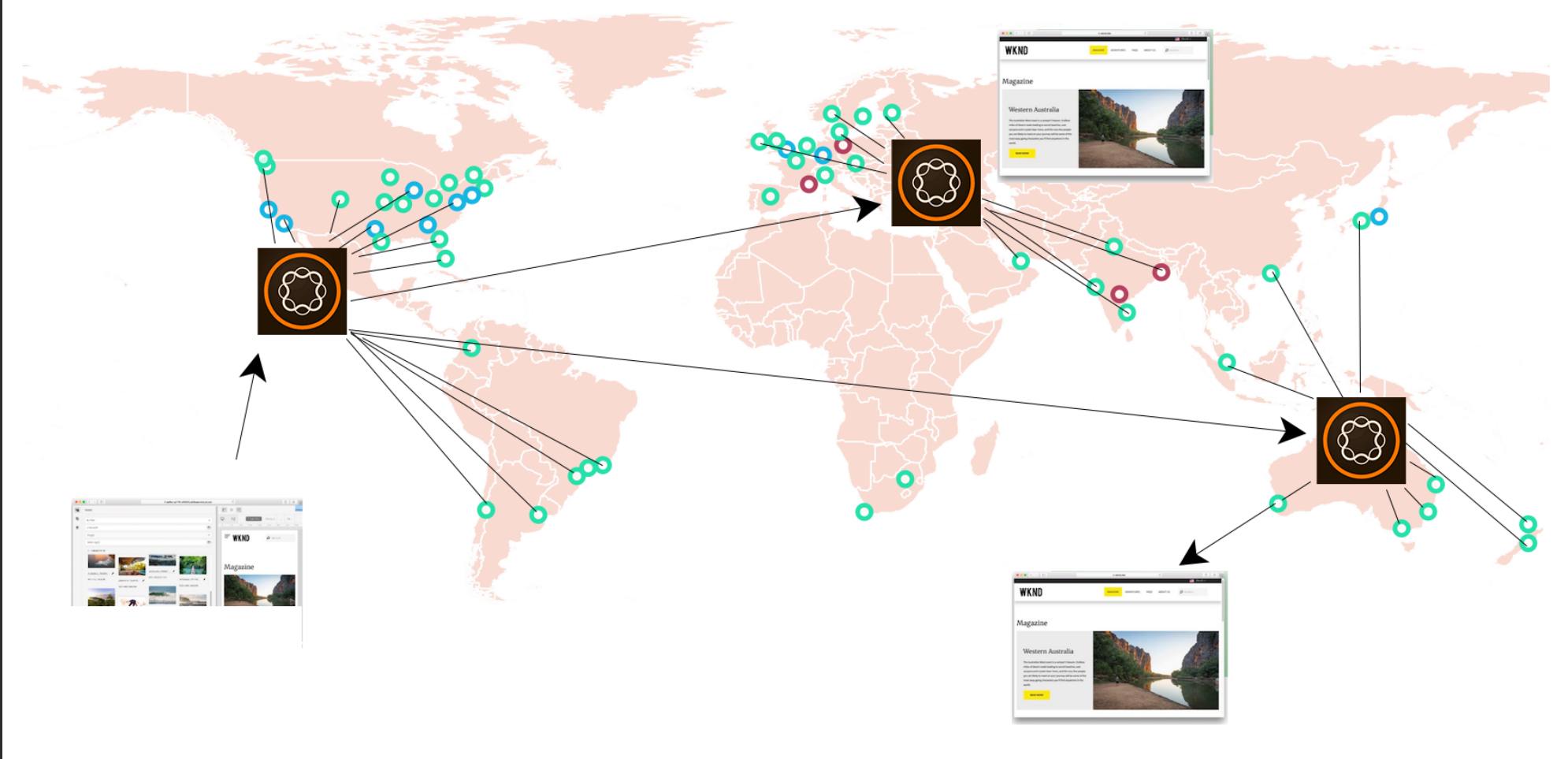











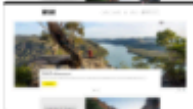





















# Demo – Response times from different locations

 **5 of 5 Locations**  
Checks Complete

 **0 of 5 Locations**  
Errors From

 **1.7 Seconds**  
Average First Visit

 **0.8 Seconds**  
Average Repeat Visit

Website Preview	Location	Load Time First Visit		Load Time Repeat Visit		Perfor...	Best Pr...	SEO
	San Francisco	0.9 s	616 KB 	0.9 s	11 KB 			 
	Brisbane	1.1 s	616 KB 	0.6 s	2 B 			 
	Buenos Aires	2.4 s	616 KB 	1.2 s	2 B 			 
	Tokyo	3.3 s	616 KB 	0.6 s	2 B 			 
	Madrid	1.0 s	616 KB 	0.7 s	2 B 			 

# Cloud Service Caching Topology

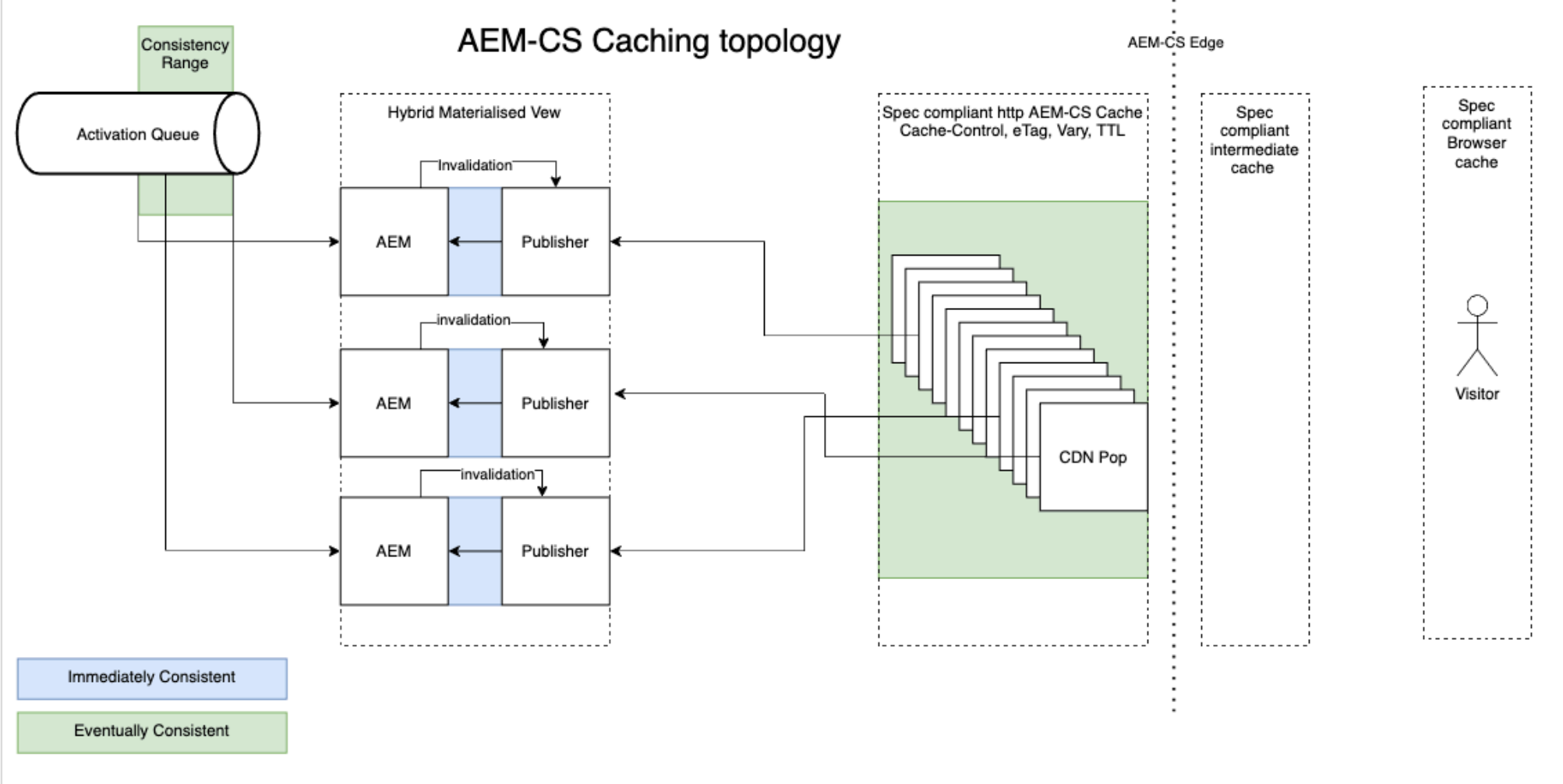

# Self-Service Configuration of the dispatcher

- Caching with AEMaaCS
  - Following standard HTTP Spec for caching will get most sites to 90%
  - For non permissioned content, goal is 100% cache ratio
  - For sure if it's under 80% we need to have a look
- Easily configure caching per path – mod\_headers
- Easily configure per content type - mod\_expires
- CDN will honour the the headers set in the dispatcher

# Caching – Using Versioned Client libs

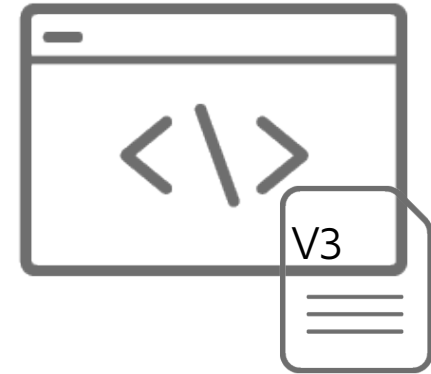
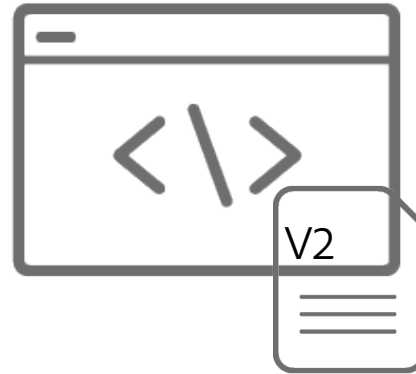
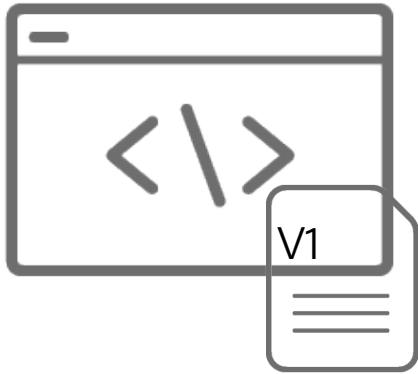

```
<link rel="stylesheet" href="/etc.clientlibs/wkndapp/clientlibs/clientlib-base.css" type="text/css">
```

```
<link rel="stylesheet" href="/etc.clientlibs/wkndapp/clientlibs/clientlib-base.lc-7c8c5d228445ff48ab49a8e3c865c562-1c.css" type="text/css">
```



# WKND Client Libs

The image shows a browser window with the WKND website. The top navigation bar includes 'SIGN IN', 'EN-US', and a search bar. The main content area features the 'WKND' logo and navigation links for 'MAGAZINE', 'ADVENTURES', 'FAQS', and 'ABOUT US'. A developer tool is open, showing a network request for a CSS file. The 'Request' tab is active, displaying the following details:

- Request URL:** `https://wknd.site/etc.clientlibs/wknd/clientlibs/clientlib-base.lc-d8827c6c5adc7f6ba662b809d0ccb54a-lc.min.css`
- Request Method:** GET
- Status Code:** 200
- Remote Address:** 151.101.3.10:443

The 'Response' tab is also open, showing the following headers:

- accept-ranges:** bytes
- age:** 88254
- cache-control:** max-age=2592000, public, immutable
- content-encoding:** gzip
- content-length:** 7659
- content-type:** text/css; charset=utf-8

The 'Name' column in the developer tool lists various resources, including 'en.html', 'wknd-icon-font.ttf', and several client library files.

# Caching – Versioned Client Libs

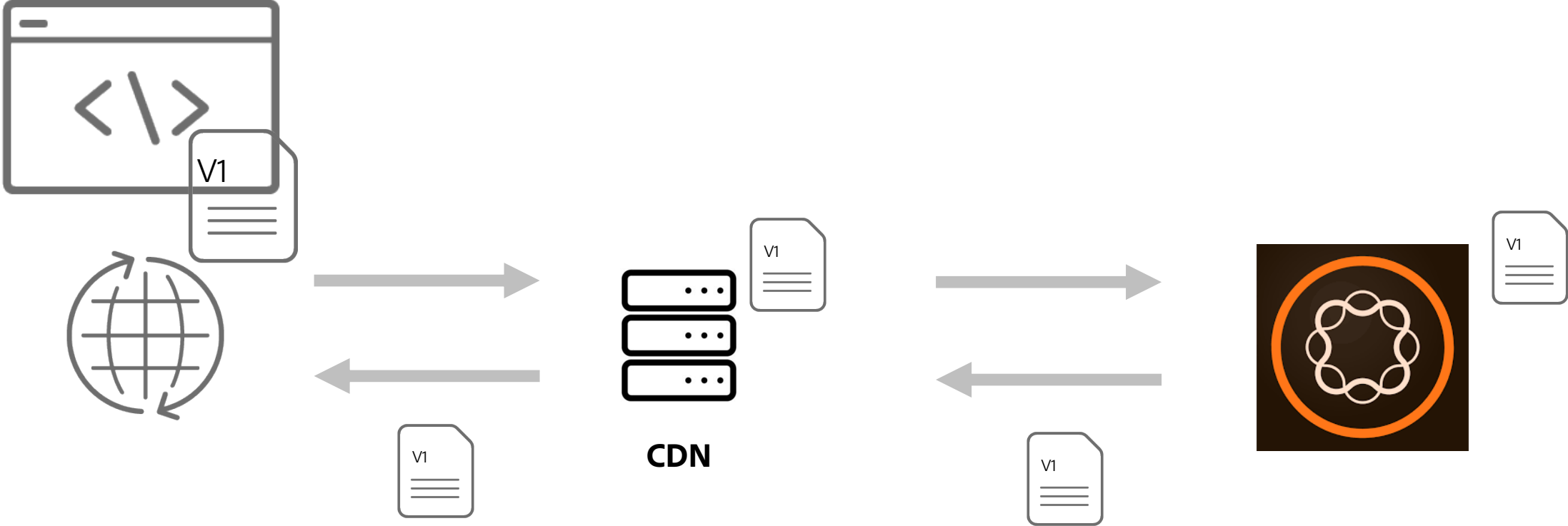

# Caching – Versioned Client Libs

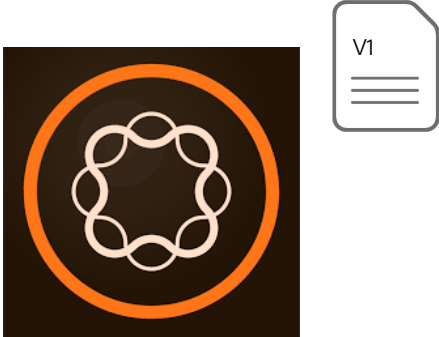
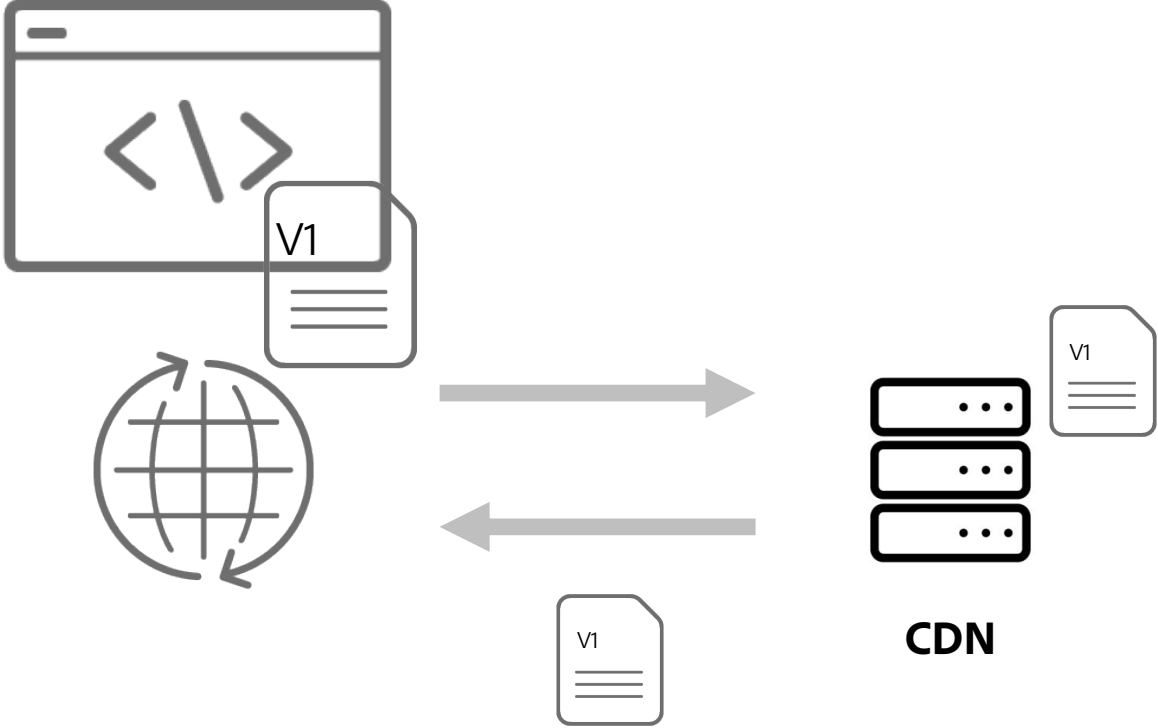

# Caching – Versioned Client Libs

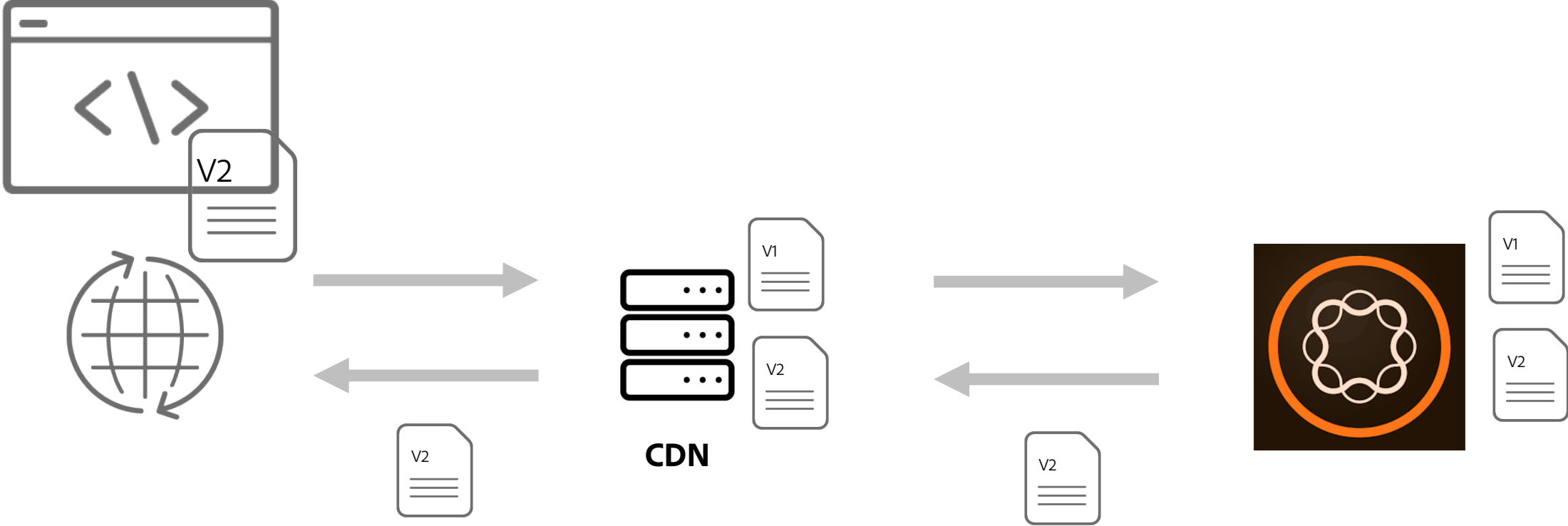

# Caching – Versioned Client Libs

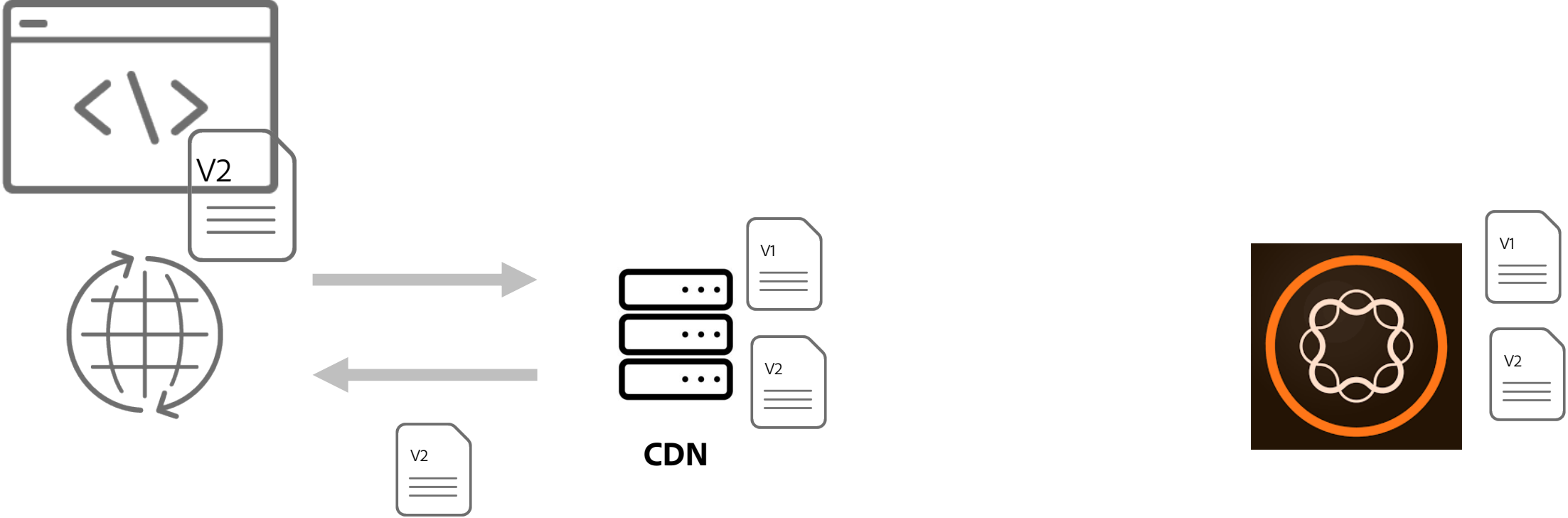

# Caching – Images and HTML

- Images are not cached by default
- HTML
  - Default is 300 seconds (5 minutes)
  - This is the recommended value for optimized caching and re-validation

```
<LocationMatch "^\.*(jpeg|jpg)$">  
  Header set Cache-Control "max-age=222"  
  Header set Age 0  
</LocationMatch>
```

```
<LocationMatch "\.(html)$">  
  Header set Cache-Control "max-age=300"  
  Header set Age 0  
</LocationMatch>
```

# Caching – Revalidation

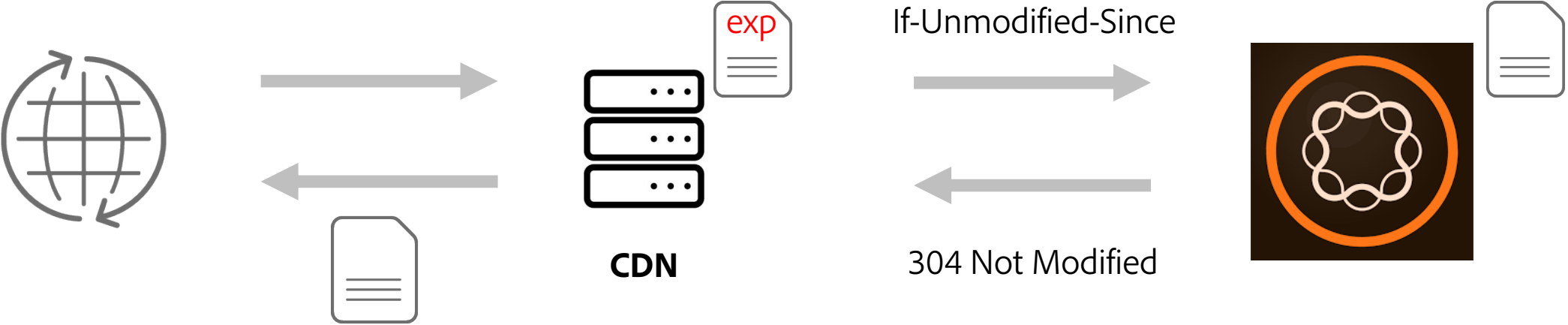

# Custom Domains

The screenshot displays the Adobe Cloud Manager interface for the 'wknd-program-prod' environment. The left sidebar shows navigation options: Environments, SSL Certificates, Domain Settings, and IP Allow Lists. The main content area is titled 'wknd-program-prod • Running' and includes a 'General' tab. Under 'Environment Information', details for Author URL, Region (East US), and AEM Release are shown. The 'Environment Segments' table lists 'Author Service', 'Publish Service (AEM)', and 'Publish Service (Dispatcher)', all in a 'Running' state. The 'Domain Names' section features a table with columns for Domain Name, SSL Certificate, and DNS Record. A green arrow points to the 'example2.adobeamcloud.alpha' entry, which is selected. Below it, the 'example.adobeamcloud.com' entry is shown with a warning icon and the text 'Does not resolve'. The 'IP Allow List' section at the bottom indicates that no IP allow list is currently applied.

SEGMENT	STATUS
Author Service	Running
Publish Service (AEM)	Running
Publish Service (Dispatcher)	Running

DOMAIN NAME	SSL CERTIFICATE	DNS RECORD
example2.adobeamcloud.alpha	Select SSL Certificate	+ Add
example.adobeamcloud.com	SSL Certificate Example	Does not resolve

IP ALLOW LIST	SERVICE APPLIED	IP / CIDR
Select IP Allow List	Select Service	+ Apply

No IP Allow List applied



# SSL Certificates

## Add SSL Certificate

Use the form below to add a new SSL certificate by supplying a certificate name, a private key, and a certificate chain. [Learn More](#)

Cloud Manager Overview Environments Activity Learn  
FoundationInternal-GA Program Overview > SSL Certificate

Foundation Internal  
Add SSL Certificate

Cloud Manager Overview Environments Activity Learn WKND  
WKND Program Program Overview > SSL Certificates Add SSL Certificate

SSL CERTIFICATE	VALID UNTIL	ISSUER	SERIAL NUMBER	DOMAIN NAMES IN USE	ENVIRONMENT ATTACHED
SSL Certificate Example	December 20, 2021	Verisign	99c27ba9-971a-4b90-b10f-49dbaf6ff620		...

- Environments
  - wknd-program-prod
  - wknd-program-stage
  - wknd-program-dev
- SSL Certificates
- Domain Settings
- IP Allow Lists

Certificate chain

Paste certificate chain here

Cancel Save

# Resources

- Caching with AEMaaCS Public Documentation: <https://tinyurl.com/c005li5n>
- Custom Domains & SSL Certificates: <https://tinyurl.com/uihihkev>
- New York Times Article: <https://tinyurl.com/1tw0q8sk>

